

Master MLS™ | 2500, 3500

MasterTig MLS™ | 3000, 4000

MasterCool™ | 10



Operating manual • English *EN*

Käyttöohje • Suomi *FI*

Bruksanvisning • Svenska *SV*

Bruksanvisning • Norsk *NO*

Brugsanvisning • Dansk *DA*

Gebrauchsanweisung • Deutsch *DE*

Gebruiksaanwijzing • Nederlands *NL*

Manuel d'utilisation • Français *FR*

Manual de instrucciones • Español *ES*

Instrukcja obsługi • Polski *PL*

Инструкции по эксплуатации • По-русски *RU*

操作手册 • 中文 *ZH*

Manual de utilização • Português *PT*

Manuale d'uso • Italiano *IT*

OPERATING MANUAL

English

CONTENTS

1. PREFACE	3
1.1 General.....	3
1.2 Product introduction.....	3
2. INSTALLATION	4
2.1 Removal from packaging.....	4
2.2 Locating the machine.....	4
2.3 Serial number.....	4
2.4 Installation.....	4
2.5 Installation of the panel.....	5
2.6 Distribution network.....	5
2.7 Mains connection.....	5
2.8 Welding cable connections.....	6
2.8.1 Choosing welding polarity in MMA welding.....	6
2.8.2 Earthing.....	6
2.9 Cooling unit to MasterCool 10.....	6
2.10 Shield gas.....	7
2.10.1 Installation of gas bottle.....	8
3. OPERATION	8
3.1 Welding processes.....	8
3.1.1 MMA welding.....	8
3.1.2 TIG welding.....	9
3.1.3 Synergic Pulsed TIG welding (a).....	9
3.1.4 Long Pulsed TIG welding (b).....	9
3.2 Operation functions.....	9
3.2.1 Power source.....	9
3.2.2 Function panels.....	9
3.2.3 Saving welding settings (MTM).....	16
3.2.4 Adopting the saved settings.....	17
3.2.5 Remote control memory channels.....	17
3.2.6 SETUP functions.....	17
3.2.7 Foot pedal control R11F.....	18
3.3 Cooling unit operation MasterCool 10.....	18
3.4 Storage.....	18
4. MAINTENANCE	18
4.1 Regular maintenance.....	18
4.1.1 Every sixth months.....	18
4.1.2 Service contract.....	19
4.2 Troubleshooting.....	19
4.3 Disposal of the machine.....	19
5. ORDERING NUMBERS	20
6. TECHNICAL DATA	22

1. PREFACE

1.1 GENERAL

Congratulations on choosing the Master/MasterTig MLS™ equipment. Used correctly, Kemppi products can significantly increase the productivity of your welding, and provide years of economical service.

This operating manual contains important information on the use, maintenance and safety of your Kemppi product. The technical specifications of the equipment can be found at the end of the manual.

Please read the manual carefully before using the equipment for the first time. For your own safety and that of your working environment, pay particular attention to the safety instructions in the manual.

For more information on Kemppi products, contact Kemppi Oy, consult an authorised Kemppi dealer, or visit the Kemppi web site at www.kemppi.com.

The specifications presented in this manual are subject to change without prior notice.

Important notes

Items in the manual that require particular attention in order to minimise damage and personal harm are indicated with the '**NOTE!**' notation. Read these sections carefully and follow their instructions.

Disclaimer

While every effort has been made to ensure that the information contained in this guide is accurate and complete, no liability can be accepted for any errors or omissions. Kemppi reserves the right to change the specification of the product described at any time without prior notice. Do not copy, record, reproduce or transmit the contents of this guide without prior permission from Kemppi.

1.2 PRODUCT INTRODUCTION

Kemppi Master MLS™ 2500 and 3500 is a MMA welding machine designed for industrial use and for welding all kinds of covered electrodes, including difficult-to-weld types such as cellulose electrodes. The equipment consists of power source, welding cables and function panel.

Kemppi Mastertig MLS™ 3000 and 4000 is a TIG welding system especially designed for industrial use and for welding e.g. stainless steel materials. The equipment consists of a power source, function panel, TIG welding torch, ground cable and an optional cooling unit. The cooling unit MasterCool 10 is used in water-cooled TIG welding.

The power source is a multifunctional machine for demanding professional use for MMA, TIG and pulsed TIG welding with direct current. The power source is controlled with IGBT transistors with a frequency of approximately 20 kHz, and the operational functions with a microprocessor. The welding torch can be either water-cooled or gas-cooled.

2. INSTALLATION

2.1 REMOVAL FROM PACKAGING

The equipment is packed in durable packages designed especially for it. However, it is necessary to check the equipment before using it to make sure that the equipment or any part of it has not got damaged during transportation. Also check that the delivery corresponds to your order and that you have received all necessary instructions for installing and operating the equipment. The packaging material is recyclable.

2.2 LOCATING THE MACHINE

Place the machine on a horizontal, stable and clean ground. Protect the machine from rain and direct sunshine. Check that there is enough space for cooling air circulation in front of and behind the machine.

2.3 SERIAL NUMBER

Serial number of the machine is marked on the rating plate. The serial number is the only proper means of identifying parts for a specific product. It is important to make correct reference to the serial number of the product when making repairs or ordering spare parts.

2.4 INSTALLATION

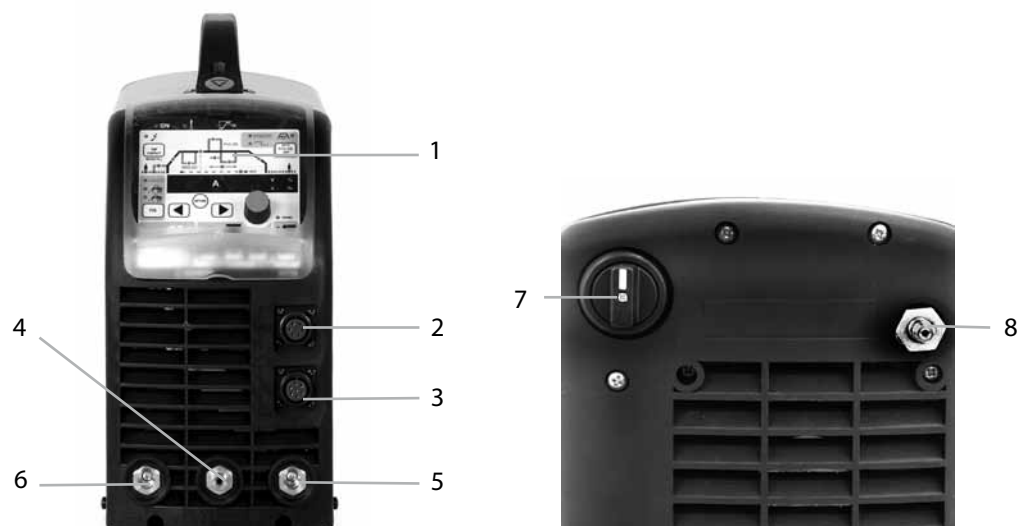

1. Function panel
2. Remote control connector
3. TIG torch control connector, not in MMA version
4. Shield gas and current connector for TIG torch, not in MMA version
5. (+) connector for electrode holder or earth cable, in TIG welding for earth cable
6. (-) connector for earth cable or electrode holder in MMA welding (stick welding)

Markings for (+/-) poles on the machine front are embossed.

Rear of machine

7. Mains switch
8. Snap connector for gas

2.5 INSTALLATION OF THE PANEL

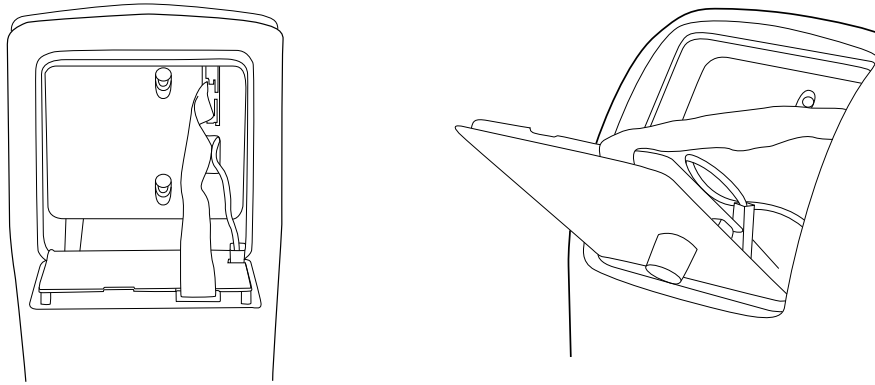

1. Fasten the cable connectors of the function panel to the power source (2 pieces).
2. Place the bottom edge of the panel behind the securing clips on the machine. Remove the fixing pin from the top edge with, for example, a screwdriver. Then gently push the upper part of the panel into place. Make sure that the cables do not get damaged, continue gently pushing the upper part of the panel until it clips into place. Finally, push the fixing pin back into its place.

2.6 DISTRIBUTION NETWORK

All regular electrical devices without special circuits generate harmonic currents into distribution network. High rates of harmonic current may cause losses and disturbance to some equipment.

Master MLS™ 2500, MasterTig MLS™ 3000

This equipment complies with IEC 61000-3-12 provided that the short-circuit power S_{SC} is greater than or equal to 1.6 MVA at the interface point between the user's supply and the public supply network. It is the responsibility of the installer or user of the equipment to ensure, by consultation with the distribution network operator if necessary, that the equipment is connected only to a supply with a short-circuit power S_{SC} greater than or equal to 1.6 MVA.

Master MLS™ 3500, MasterTig MLS™ 4000

This equipment complies with IEC 61000-3-12 provided that the short-circuit power S_{SC} is greater than or equal to 2.5 MVA at the interface point between the user's supply and the public supply network. It is the responsibility of the installer or user of the equipment to ensure, by consultation with the distribution network operator if necessary, that the equipment is connected only to a supply with a short-circuit power S_{SC} greater than or equal to 2.5 MVA.

2.7 MAINS CONNECTION

NOTE! Only an authorised electrician is allowed to install mains cable and plug!

The power source is equipped with a 5-meter mains cable without plug. The fuse and cable sizes are given in the Technical data at the end of this manual.

NOTE! This equipment's electromagnetic compatibility (EMC) is designed for use in an industrial environment. Class A equipment is not intended for use in residential location where the electrical power is provided by the public low-voltage supply system.

2.8 WELDING CABLE CONNECTIONS

2.8.1 Choosing welding polarity in MMA welding

You can change the welding polarity by choosing (+) or (-) cable connector.

2.8.2 Earthing

If possible, always fasten the earth clamp of return current cable directly onto work piece.

1. Clean contact surface of earth clamp from paint and rust.
2. Fasten clamp properly, so that contact surface is as large as possible.
3. Check that clamp is fastened firmly.

2.9 COOLING UNIT TO MASTERCOOL 10

NOTE! Cooling liquid is injurious! Avoid also contact with skin or eyes. In case of injury, seek for medical advice.

Cooling unit MasterCool 10 together with TIG torch of Kemppi's TTC-W range enables TIG welding with water-cooled torch.

The cooling unit is installed beneath the power source with screws. Electrical connections are on the bottom of power source. Fill the reservoir with a 20 - 40 % mixture of etanol and water, or with any other suitable antifreeze. The capacity of the reservoir is 3 litres.

MasterCool 10:

Mastertig MLS 3000

Mastertig MLS 4000

Installation of cooling unit

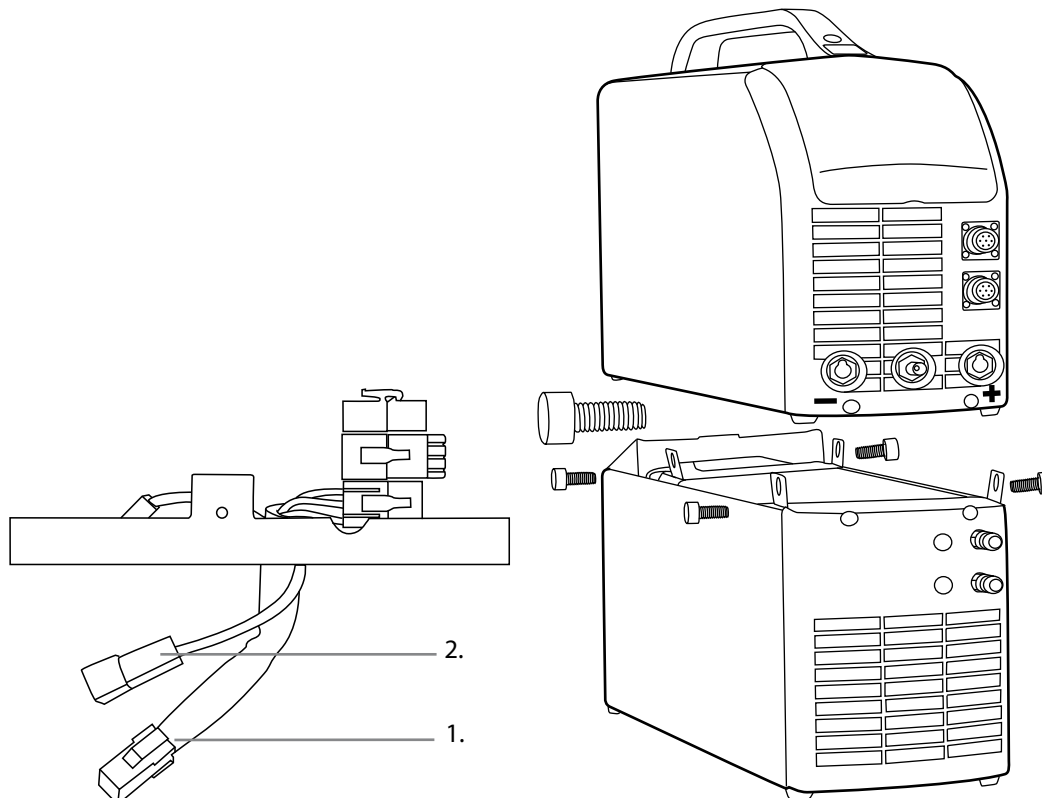

Installing gas-cooled torch

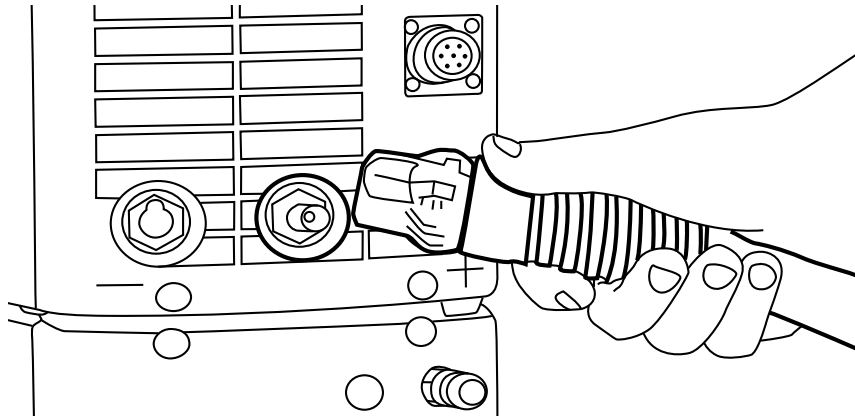

Installing water-cooled torch

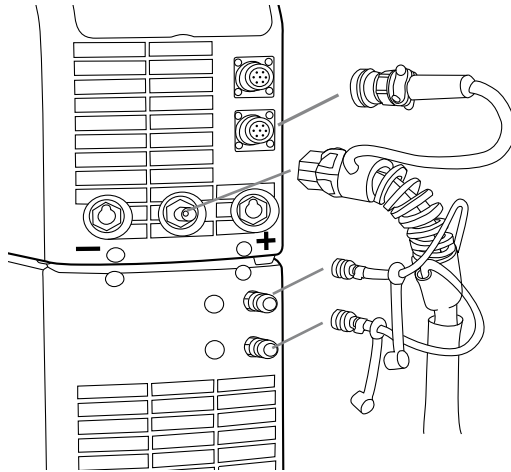

Connect the red water hose to the upper connector and blue one to the lower connector..

2.10 SHIELD GAS

NOTE! Handle gas bottle with care. There is a risk for injury if gas bottle or bottle valve is damaged!

Use inert gases such as argon, helium or argon-helium mixture as shield gas for TIG welding. Make sure that the gas flow regulator is suitable for the gas type used. The flow rate is set according to the welding current, joint form and the size of the electrode. A suitable flow rate is normally 8 – 10 l/min. If the gas flow is not suitable the welded joint will be porous. Spark ignition becomes more difficult if the gas flow is too high. Contact your local Kemppi dealer for choosing gas and equipment.

2.10.1 Installation of gas bottle

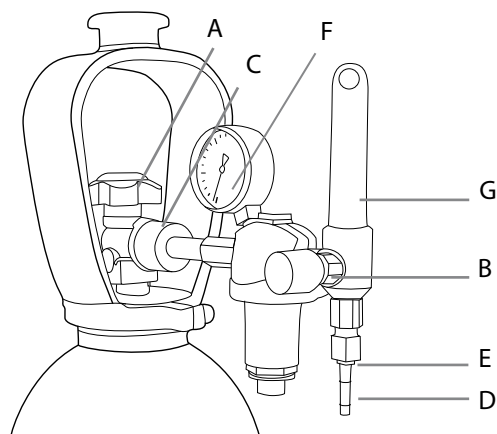

Parts of gas flow regulator

- A. Gas bottle valve
- B. Pressure regulation screw
- C. Connecting nut
- D. Hose spindle
- E. Jacket nut
- F. Gas bottle pressure meter
- G. Gas hose pressure meter

NOTE! Always fasten gas bottle properly in vertical position in a special holder on the wall or on a carriage. Remember to close gas bottle valve after having finished welding.

The following installation instructions are valid for most gas flow regulator types:

1. Step aside and open the bottle valve (A) for a while to blow out possible impurities from the bottle valve. Note! Watch out for the gas flow.
2. Turn the pressure regulation screw (B) of the regulator until no spring pressure can be felt.
3. Close needle valve if there is one in the regulator.
4. Install the regulator on bottle valve and tighten connecting nut (C) with a wrench.
5. Install hose spindle (D) and jacket nut (E) into gas hose and tighten with hose clamp.
6. Connect one end of the hose with the regulator and the other end with the power source. Tighten the jacket nut.
7. Open bottle valve slowly. Gas bottle pressure meter (F) shows the bottle pressure. Note! Do not use the whole contents of the bottle. The bottle should be filled when the bottle pressure is 2 bar.
8. Open needle valve if there is one in the regulator.
9. Turn regulation screw (B) until hose pressure meter (G) shows the required flow (or pressure). When regulating flow amount, the power source should be switched on and the gun switch pressed simultaneously.

Close bottle valve after having finished welding. If the machine will be out of use for a long time, unscrew the pressure regulation screw.

3. OPERATION

NOTE! Welding in places presenting an immediate fire or explosion hazard is forbidden!
Welding fumes may cause injury, take care of sufficient ventilation during welding!

3.1 WELDING PROCESSES

3.1.1 MMA welding

MMA welding, as well as carbon arc gouging, is possible with all Master MLS and Mastertig MLS power sources with all MLS panel versions when switched to MMA process.

3.1.2 TIG welding

Mastertig MLS power sources are designed especially for TIG welding. They are equipped with HF spark ignition and versatile panel functions depending on the panel used. The panels predominantly for TIG welding are MTL, MTX, MTZ and MTM. Also the MEL and MEX panel on Master MLS power source can be used for TIG welding with contact ignition.

3.1.3 Synergic Pulsed TIG welding (a)

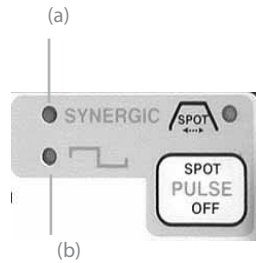

MTX, MTZ and MTM panels include the synergic pulsed TIG process, in which you only need to adjust the welding current while other pulse parameters are programmed. Pulsing frequency is high, which guarantees concentrated arc and increased welding speed.

3.1.4 Long Pulsed TIG welding (b)

This method gives you the possibility to adjust all pulse parameters. Weld pool control is also easier. Long pulsed TIG welding is included in MTX, MTZ and MTM panels.

3.2 OPERATION FUNCTIONS

3.2.1 Power source

NOTE! Always switch the machine on and off from main switch. Do not use the mains plug for switching!

Never watch the arc without a proper face shield designed for arc welding! Protect yourself and the surroundings against welding arc and hot spatters!

3.2.2 Function panels

Before welding starts, welding settings suitable for the work piece are chosen with the function panel. See 3.1. Welding processes.

The Kemppi Multi Logic System, MLS™, allows you to select from different function panels according to your welding application. MEL and MEX panels are designed for MMA welding. MTL, MTX, MTZ and MTM panels are for TIG welding with basic functions, or with pulsed TIG, 4T-LOG, or MINILOG control of welding current, or with memory channels. See also 3.1. Welding processes.

Indicator lights

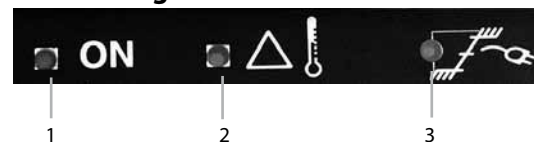

1. Power On
2. Thermal overload of power source
3. Wrong mains voltage, over or under-voltage

MMA welding panel MEL

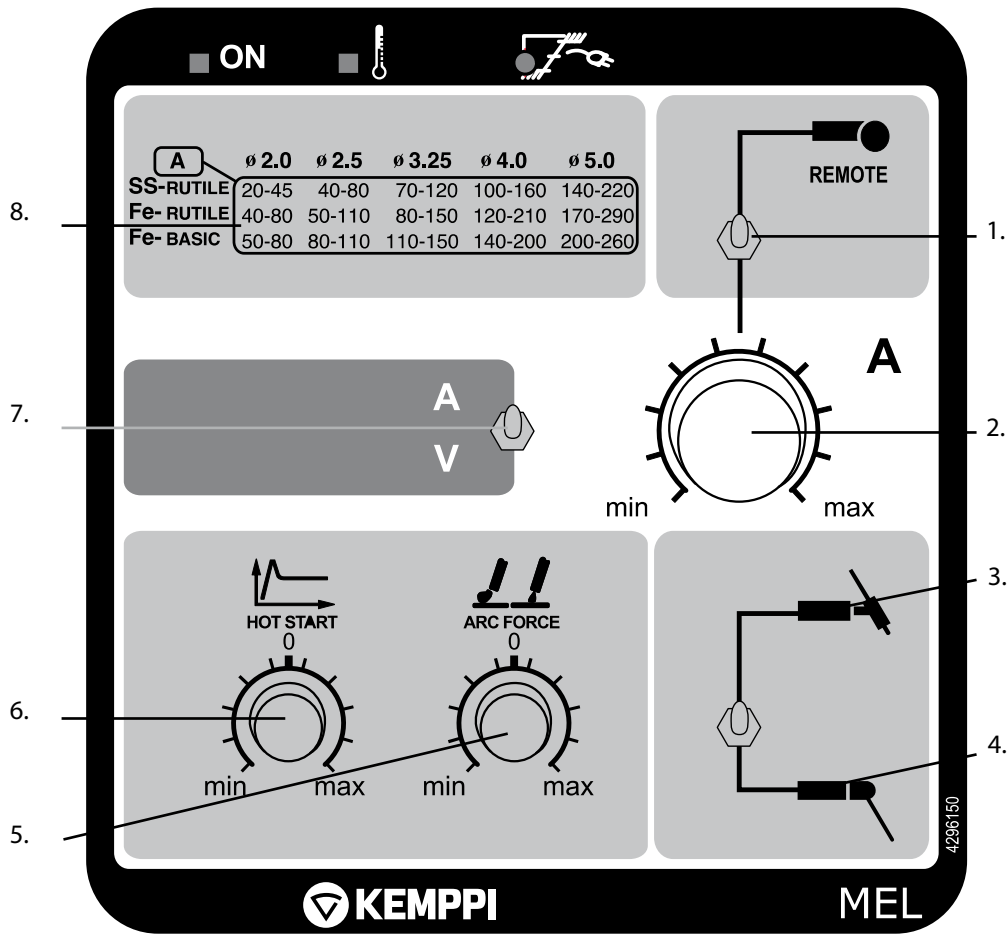

1. Remote/local control switch
2. Welding current potentiometer
3. Contact TIG welding
4. MMA welding
5. Arc force
6. Hot start
7. Digital display and amperage/voltage switch
8. Welding current table

MMA welding panel MEX

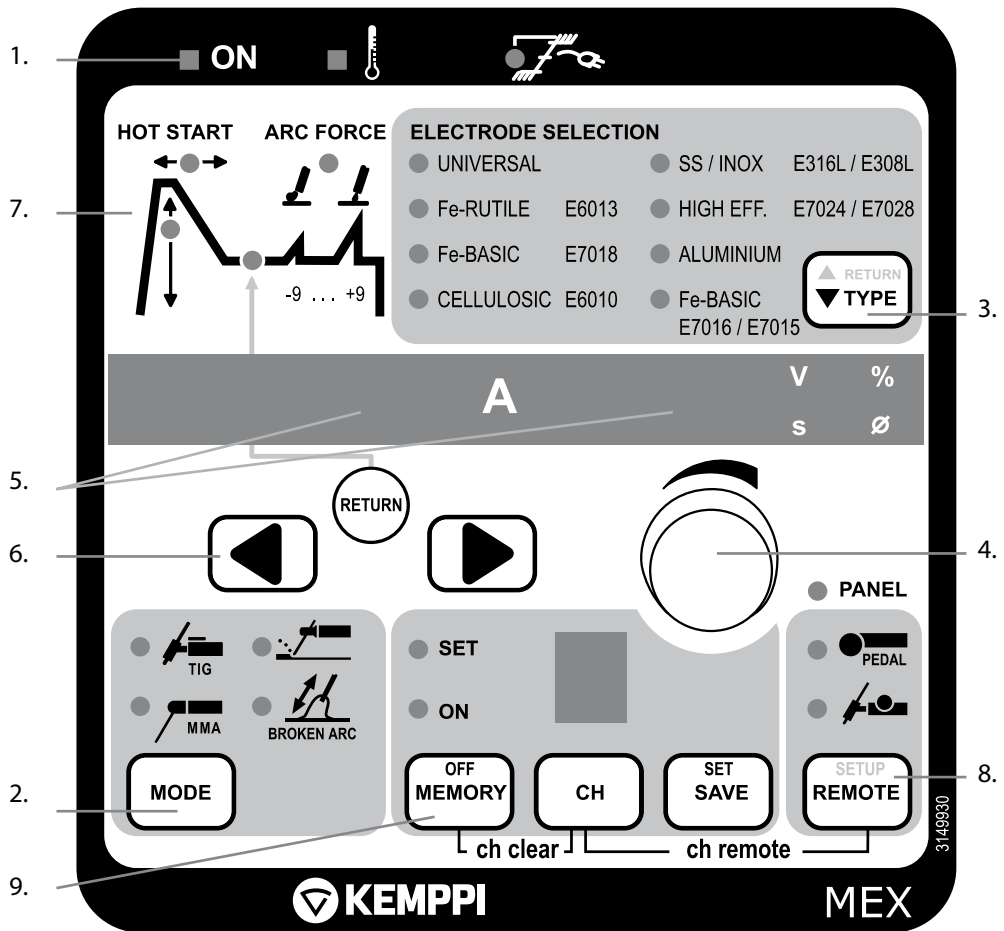

MEX panel is available separately. The functions of MEX panel are described in the operating manual delivered with the panel.

- Indicator lights: Main switch, overheating, wrong mains voltage
- MODE button for welding method selection: MMA, contact TIG, carbon arc gouging, broken arc
- Selection of electrode type
- Potentiometer for regulation of welding current and other parameters
- Displays of welding current and other parameters (A, V, s, mm)
- Selection of welding parameter to be regulated (arrow button to the left / to the right, focusing (RETURN))
- Figure indicating selection of welding parameter: HOT START, A, ARC FORCE
 - Hot start regulation (HOT START)
 - Welding current (A)
 - Arc force control dynamics (ARC FORCE)
- Selection of remote control / SETUP function
- Memory functions

TIG welding panel MTL – basic functions

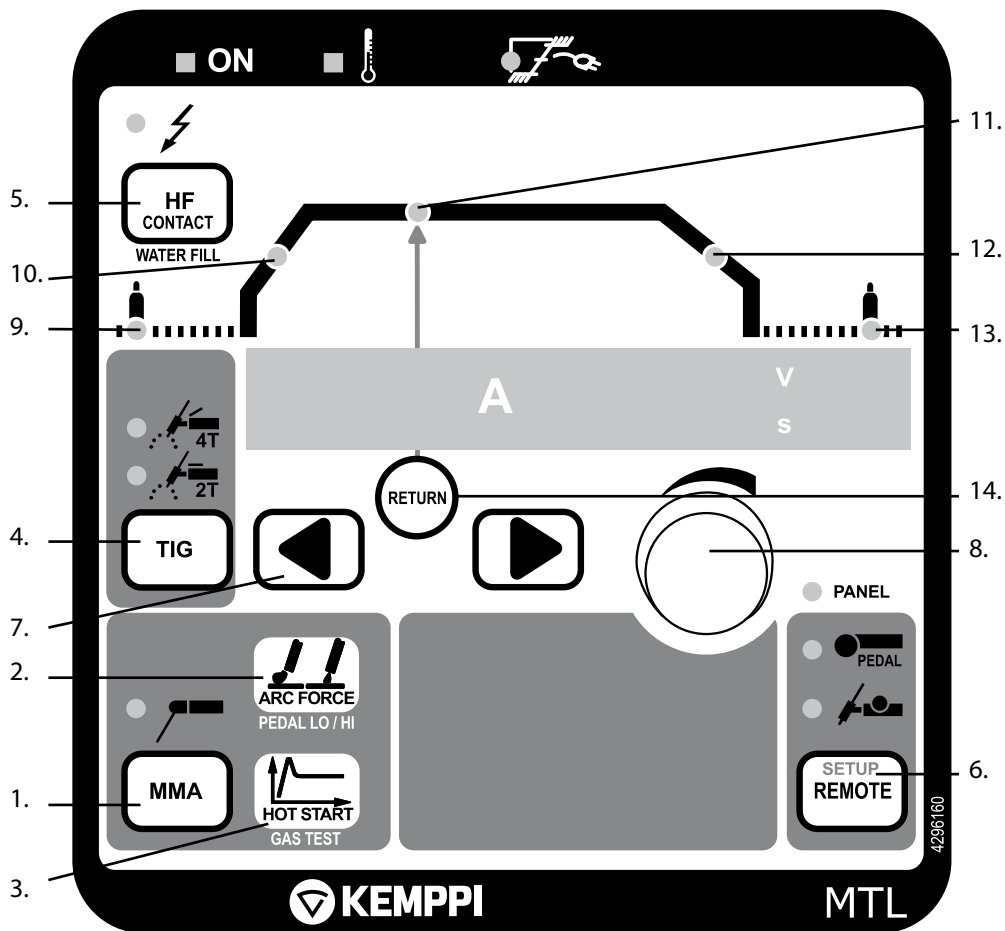

1. Selection of MMA welding
2. Selection of arc force (MMA) and pedal low/high (minimum and maximum welding current) displays and regulation (TIG welding)
3. Selection of hot start (MMA) and gas test (TIG welding)
4. Selection of TIG welding, 4T and 2T functions of torch switch
5. Selection of HF/contact and water fill function
6. Selection of panel, foot pedal and remote control
7. Selection of welding parameters
8. Adjustment of welding parameters
9. Pre-gas 0 – 10 s
10. Upslope 0 – 10 s
11. Welding current
12. Downslope 0 – 15 s
13. Post-gas 1 – 30 s
14. Return to welding current

1. MMA

Select MMA welding by pressing the selection button of MMA welding. The led is lit when MMA is on.

2. Arc force

Press the arc force button and you will see the numerical value corresponding to the MMA dynamics in the display. Factory setting for all electrode types is zero. You can change the value by turning the pulse potentiometer. If numerical value is adjusted negative (-1...9) the arc is softened, and the amount of spatter decreases when welding at the upper end of the recommended current range of the electrode. On the positive side (1...9) the arc is rough. In TIG mode, you can select the max. and min. current for the foot pedal (PEDAL LO/HI).

3. Hot start

When pressing the hot start button, you will see on the display the numerical value corresponding to the MMA hot start pulse. You can adjust the value by turning the potentiometer. In TIG mode you can select gas test function.

4. TIG welding is selected

Welding torch switch 2 sequence function

Gas flow starts when the torch switch is pressed. After preset pre-gas time welding starts, and current will rise to the welding level within the up-slope time. Release the torch switch, and the current starts to drop, and after the selected down-slope time the arc is broken. After this, the shield gas will flow for the time selected.

Welding torch switch 4 sequence function

Gas flow starts when the torch switch is pressed. Release the torch switch. The ignition spark ignites the arc, and the current will rise to the welding level within the up-slope time. Press the torch switch down, and the welding continues. Release the torch switch, and the current starts to drop and after the selected down-slope time the arc is broken. After this, the shield gas will flow for the time selected.

5. HF/contact ignition in TIG welding (water fill)

TIG arc can be started either with high frequency (HF) or without (contact ignition). HF ignition is chosen by pressing the HF CONTACT button (5) to turn on the HF light.

If you use water-cooled torch you can fill it with water by pressing the HF CONTACT button for more than 2 seconds.

6. Remote control

If you choose to adjust the welding current with a remote control unit you need to connect the unit and select the REMOTE button. The panel led switches off and you can select the unit (R10, wireless remote control R11T for MMA welding, or foot pedal control R11F). There is an automatic recognition of remote control units with potentiometers and only the symbol of a connected unit can be chosen. The foot pedal control works only in 2T mode.

7., 8. and 14. Adjustment of parameters

To select TIG welding parameters you only need to use two buttons: arrow-left and arrow-right. Adjustment is done with the potentiometer. When pressing the RETURN button, adjustment of parameters goes straight to welding current. The display shows automatically numeric values and the units of the parameters. When you adjust the parameters, you can see the value on the numerical display. After 10 seconds, the display will return to the welding current.

TIG welding panel MTX – pulsed TIG functions

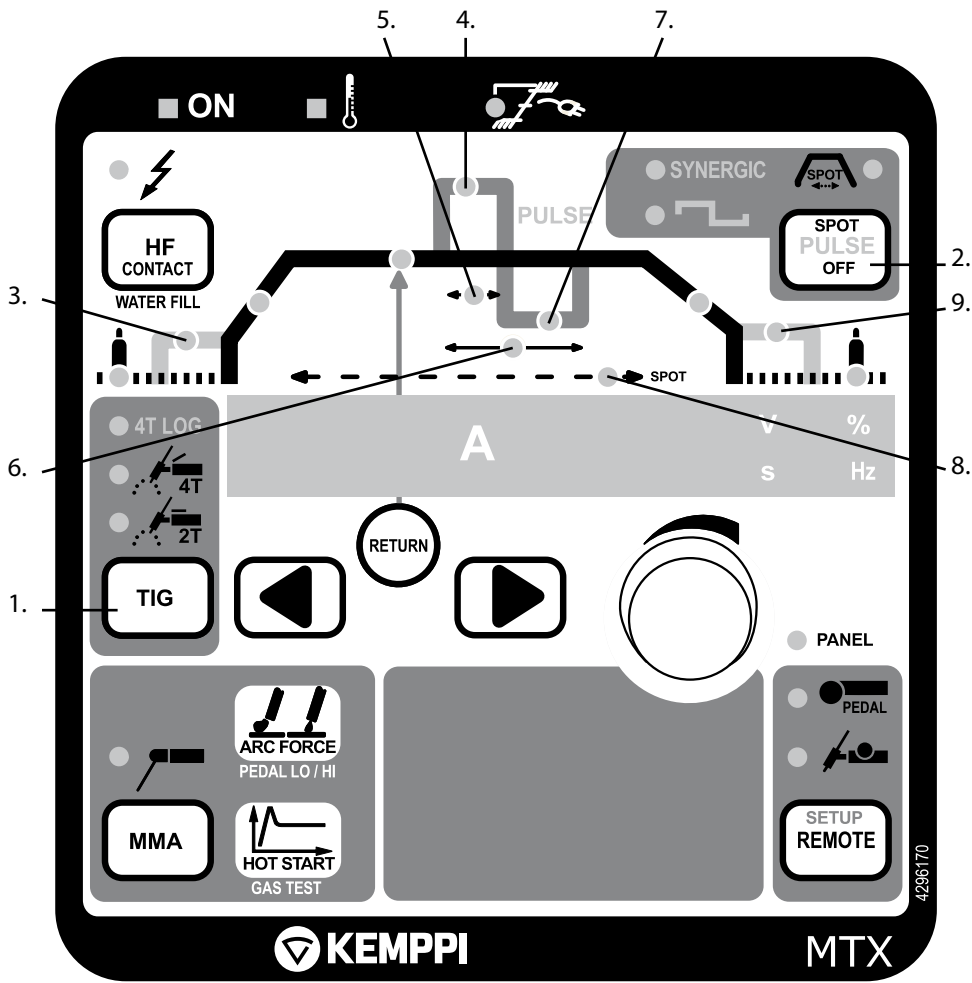

1. 4T-LOG
2. Selection for spot, synergetic quick pulse and long pulse
3. Search arc 10 – 80 % of welding current
4. Pulse current 10 A – max.
5. Pulse ratio 10 – 70 % of pulse time
6. Frequency 0.2 – 300 Hz
7. Base current 10 – 70 % of pulse current
8. Spot time 0 – 10 slph
9. Tail arc 10 – 80 % of welding current

1. Welding torch switch 4T-LOG function (only MTX panel)

When torch switch is pressed current goes to search arc; after the switch is released current goes to welding current within the upslope time. When the switch is pressed again, current goes to downslope and then to the tail arc. Current stops when the switch is released.

2. Spot

Spot function is practical when welding a definite spot with TIG. It can be used both in 2T and 4T mode. Enter the spot time adjustment by pressing arrow button, and when the led is lit you can choose the spot time needed by turning the pulse potentiometer.

Synergetic quick pulse

Press the PULSE button twice and the synergetic light turns on. Pulse parameters are calculated automatically when average welding current is selected. Other pulse selections are not necessary.

Long pulse

Long pulse method gives you the possibility to adjust all pulse parameters (pulsing frequency, pulse ratio, pulse current and pause current). You can also adjust the welding current, in which case you receive a new pulse current value. Pulse ratio and pause current percentage remain constant. When you adjust the pulse ratio, pulse current or pause current, the new average welding current value is shown on the display.

TIG welding panel MTZ – pulsed TIG and MINILOG function

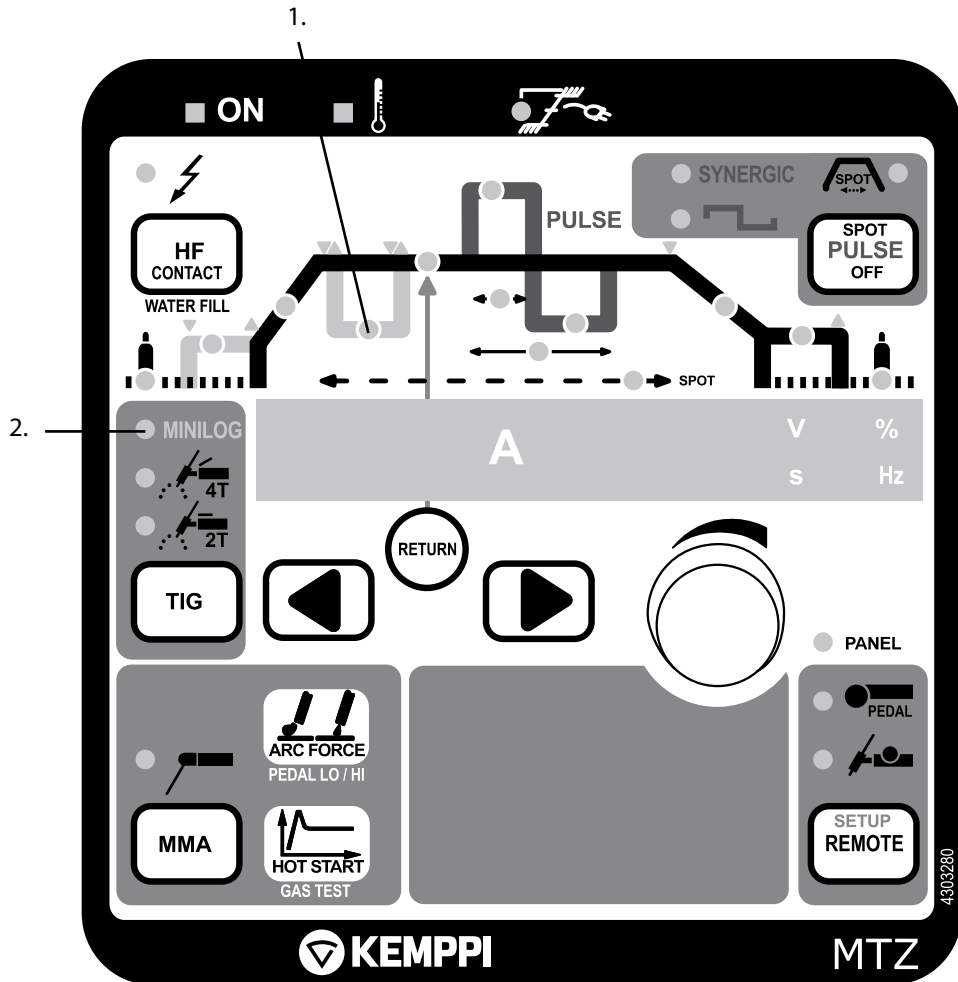

1. Minilog
2. Minilog 10 – 90 % of welding current

MTZ Minilog

When torch switch is pressed current goes to search arc; after the switch is released current goes to welding current within the upslope time. With Minilog operation you can select from two current levels: the welding current and the Minilog current. You can move from one to the other by quickly pressing the torch switch. Press torch switch for 1 second, current goes to downslope and then to the tail arc. Current stops when the switch is released.

TIG welding panel MTM – pulsed TIG and MINILOG function with memory

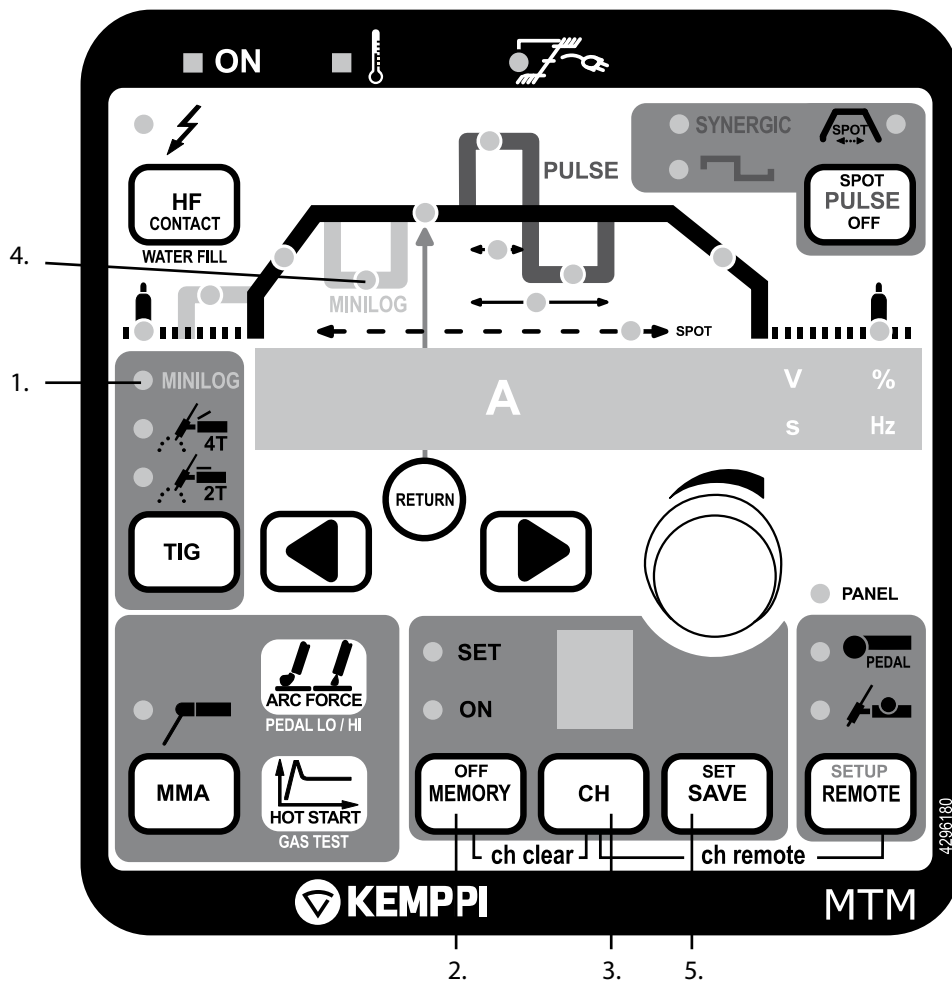

1. Minilog
2. Selection of memory function
3. Selection of channel in memory function
4. Minilog 10 – 90 % of welding current
5. SAVE

Minilog operation

When torch switch is pressed gas flow starts. When you release the switch current goes to search arc. A quick press on the switch, and current goes to welding current within the upslope time. After another short press it goes to Minilog operation, and you can select from two current levels: the welding current and the Minilog current. You can move from one to the other by quickly pressing the torch switch. Press the torch switch for 1 second, release it and current goes to downslope.

3.2.3 Saving welding settings (MTM)

MTM panel has 10 memory channels for user settings. The selections are made in the MEMORY field. Not only welding parameters but also function selections can be saved in the memory. MMA welding values can also be stored in memory channels. Proceed as follows:

1. Press MEMORY button twice and if the SET light starts blinking the channel is free. If the channel is reserved the led will remain lit.
2. Select memory channel by pressing CH button.
3. Select the parameters and press SAVE button.
4. Press MEMORY button twice. ON led is lit.
5. Start welding and adjust settings if necessary.

If the saved settings need to be adjusted the led has to be moved from ON to SET position in order to select parameters. Press the SAVE button. It is also possible to save the currently used parameters by pressing SET when the memory function is in OFF state (no lights on). Channel is cleared if MEMORY and CH buttons are pressed simultaneously in SET mode.

3.2.4 Adopting the saved settings

1. Select MEMORY by pressing the button.
2. Select memory channel by pressing the CH button.
3. Start welding.

3.2.5 Remote control memory channels

Memory channels are selected by pressing simultaneously both REMOTE and CH button. With the remote control you can retrieve saved settings on memory channels.

3.2.6 SETUP functions

A so called SETUP state is included for modifying panel functions. You can enter the SETUP state by pressing the REMOTE (SETUP) button longer than normally. Exit is performed in the same way. You can select the function (see list below) by pressing the arrow buttons and then change the setting by turning the potentiometer.

Display	Function	Factory setting
A1	Upslope with constant time setting / gradient (steepness) setting	0 constant time
A2	Downslope with constant time setting / gradient (steepness) setting	0 constant time
A3	TIG antifreeze off / on	1 off
A4	MMA antifreeze off / on	1 on
A5	MMA hot start pulse non adaptive / adaptive	0 non adaptive
A6	Downslope cut off on / off	0 on
A7	MMA open circuit voltage 80V / 40V	0 80 V
A8	2T downslope normal / cuts off by short switch action	0 normal
A9	Tacking automatics off / on	0 off
A10	Current at arc start steep / slightly sloped	0 steep.
A11	Downslope linear / non-linear	0 linear
A12	MMA/TIG method selection with remote control off / on	0 off
A13	Search arc off / on	1 on
A14	Possibility to current freezing during downslope off / on	0 off
A15	Control of channels with torch up-down switch off / on	0 off
A16	Control of current with torch up-down switch always active / active only when selected with REMOTE button	0 always active
A17	Guard functions of cooling unit not activated / activated	1 activated
A18	Downslope for Minilog and 4T in MTM and MTL panels performed during long switch action / after switch operation (normal)	0 normal
A19	Cooling unit operates on forced control / automatic on/off control	0 automatic

3.2.7 Foot pedal control R11F

First read under "3.2.2.4. TIG welding panel MTL" point "6. Remote control" for installing the remote control ready for operation. Foot pedal R11F is used in TIG welding, and its control range is adjustable. The minimum value of control range is set with the panel potentiometer when the pedal is not pressed, display shows "LO". Control range maximum is set similarly by pressing first the PEDAL LO/HI button on the panel, display shows "HI". Welding is started with a light press on the pedal, the arc ignites to the set minimum current. Welding current goes to maximum when the pedal is pressed to the bottom. The arc is broken when the pedal is released. Adjust again if necessary.

3.3 COOLING UNIT OPERATION MASTERCOOL 10

The operation of cooling unit MasterCool 10 is controlled by the power source. The cooling unit pump starts automatically when welding starts. Proceed as follows:

1. Start power source.
2. Check water level and input flow of the reservoir, add liquid if needed.
3. If you use a water-cooled torch you can fill it with water by pressing WATER FILL (HF CONTACT) button for more than 2 seconds.

The pump operates for 5 another minutes after welding has been finished to cool the water to the same temperature as in the machine surrounds. This reduces the need of service.

Thermal overload

The thermal overload light is lit, the machine stops and display shows COOLER when temperature control of the machine has detected cooling water overheating. The cooling unit fan cools down the water, and when the light goes out welding can be started again.

Water flow signal

Display shows COOLER when there is no pressure enough for water to flow.

3.4 STORAGE

The machine must be stored in a clean and dry room. Protect the machine from rain and direct sunshine in places where temperature exceeds +25 °C.

4. MAINTENANCE

NOTE! Watch out for mains voltage when handling electric cables!

Degree and circumstances of machine utilisation should be taken into consideration when planning product maintenance. Careful use and preventive maintenance help to avoid unnecessary production disturbances and breaks. Check the condition of the welding and connection cables daily. Do not use damaged cables.

4.1 REGULAR MAINTENANCE

4.1.1 Every sixth months

NOTE! Disconnect the plug of the machine from the mains socket and wait for ca. 2 minutes (capacitor charge) before removing the casing plate.

The following maintenance operations should be carried out at least every sixth months:

- Electric connections of the machine – clean any oxidised parts and tighten any loose ones. NOTE! You must know the correct tension torques before you start repairing the connections.
- Clean the inner parts of the machine from dust and dirt e.g. with a soft brush and a vacuum cleaner. Do not use compressed air because there is the danger that the dirt is packed even more tightly in the gaps of the cooling profiles. Do not use a pressure washer.

NOTE! Only an authorised electrician may repair the machine.

4.1.2 Service contract

KEMPPI service workshops make special service contracts with customers about regular maintenance. All parts are cleaned, checked and if necessary, repaired. Also the operation of welding machine is tested.

4.2 TROUBLESHOOTING

Power On light is not lit.

There is no power in the machine.

- Check mains fuses, replace blown fuses.
- Check mains cable and plug, replace defect parts.

The machine is not welding properly.

There are plenty of spatters during welding. Weld joint is porous or power supply is insufficient.

- Check welding settings and adjust if needed.
- Check gas flow and gas hose connection.
- Check that earth clamp is properly fastened and that earth cable has no defects. Change the position if necessary and replace defect parts.
- Check welding torch cable and connector. Tighten the connection and replace defective parts.
- Check the consumable parts of welding torch. Clean and replace defect parts.
- Check mains fuses, replace blown fuses.

Power source overheat indicator light is lit.

Power source is overheated.

- Check that there is enough free space behind the machine for cooling air circulation.
- Check cooling unit for water circulation, cleanliness of heat exchanger and air grate. Add cooling liquid if necessary.

For further information and assistance, contact your nearest Kemppi service workshop.

4.3 DISPOSAL OF THE MACHINE



Do not dispose of electrical equipment with normal waste!

In observance of European Directive 2002/96/EC on waste electrical and electronic equipment, and its implementation in accordance with national law, electrical equipment that has reached the end of its life must be collected separately and taken to an appropriate environmentally responsible recycling facility.

The owner of the equipment is obliged to deliver a decommissioned unit to a regional collection centre, per the instructions of local authorities or a Kemppi representative. By applying this European Directive you will improve the environment and human health.

5. ORDERING NUMBERS

Master MLS™ 2500		6104250
Welding cable 35 mm ²	2.5 m	6184301
Earth cable 25 mm ²	2.5 m	6184311
Electric plug 16 A	5-poles	9770812

Master MLS™ 3500		6104350
Welding cable 50 mm ²	2.5 m	6184501
Earth cable 50 mm ²	2.5 m	6184511
Electric plug 16 A	5-poles	9770812

Mastertig MLS™ 3000		6114300
Torches		
TTC 160	4m	627016004
TTC 160	8m	627016008
TTC 160	16m	627016016
TTC 220	4m	627022004
TTC 220	8m	627022008
TTC 220	16m	627022016
Earth cable 35 mm ²	5 m	6184311
Electric plug 16 A	5-poles	9770812
Gas flow meter AR/clock		6265136

Mastertig MLS™ 4000		6114400
Torches		
TTC 160	4 m	627016004
TTC 160	8 m	627016008
TTC 160	16 m	627016016
TTC 220	4 m	627022004
TTC 220	8 m	627022008
TTC 220	16 m	627022016
Earth cable 35 mm ²	5 m	6184311
Electric plug 16 A	5-poles	9770812
Gas flow meter Ar/clock		6265136

MasterCool 10		6122350
Water-cooled torches		
TTC 200W	4 m	627020504
TTC 200W	8 m	627020508
TTC 200W	16 m	627020516
TTC 250W	4 m	627025504
TTC 250W	8 m	627025508
TTC 250W	16 m	627025516

Panels		
MEL	MMA	6106000
MEX	MMA	6106010
MTL	TIG	6116000
MTX	TIG 4T-LOG	6116005
MTZ	TIG MINILOG	6116015
MTM	TIG MEMORY	6116010
Optional device		
TIG torch controls		
RTC 10		6185477
RTC 20		6185478
Remote control		
R 10		6185409
R11T		6185442
R11F		6185407
Transport unit		
T100		6185250
T110		6185251
T130		6185222
T200		6185258

6. TECHNICAL DATA

Power source Master MLS™ 2500		
Connection voltage	3~50/60 Hz	400V -15 %...+20 %
Rated power at max. current	40% ED MMA	9.4 kVA
	30% ED TIG	8.4 kVA
Connection cable	HO7RN-F	4G1.5(5m)
Fuse (delayed)		10 A
Duty cycle 40 °C	MMA	10 A/20.5 V...250 A/30.0 V
	TIG	5 A/10.0 V...300 A/22.0 V
Max welding voltage		36 V / 250 A
Stick electrodes		Ø1.5...5.0 mm
Open circuit voltage		80 V
Welding current control		stepless
Efficiency at max. current		86 % (250 A/30.0 V)
Power factor at max. current		0.95 (250 A/30.0 V)
Idle power		approx. 10 W
Degree of protection		IP23S
EMC class		A
Minimum short circuit power S_{sc} of supply network*		1.6 MVA
External dimensions	LxWxH	500x180x390 mm
Weight		20 kg

Power source Master MLS™ 3500		
Connection voltage	3~50/60 Hz	400 V -15 %...+20 %
Rated power at max. current	40% ED MMA	15 kVA
	30% ED TIG	13.8 kVA
Connection cable	HO7RN-F	4G2.5(5m)
Fuse (delayed)		16 A
Duty cycle 40 °C	MMA	10 A/20.5 V...350 A/34.0 V
	TIG	5 A/10.0 V...400 A/26.0 V
Max. welding voltage		45 V / 350 A
Stick electrodes		Ø 1.5...6.0 mm
Open circuit voltage		80 V
Welding current control		stepless
Efficiency at max. current		86 %
Power factor at max. current		0.95 (350 A/34.0 V)
Idle power		approx. 10 W
Degree of protection		IP23S
EMC class		A
Minimum short circuit power S_{sc} of supply network*		2.5 MVA
External dimensions	LxWxH	500x180x390 mm
Weight		21 kg

Power source Mastertig MLS™ 3000		
Connection voltage	3~ 50/60 Hz	400V –15%...+20%
Rated power at max. current	30% ED TIG	8.4 kVA
	40% ED MMA	9.4 kVA
Connection cable	H07RN-F	4G1.5(5m)
Fuse (delayed)		10 A
Duty cycle 40 °C	MMA	10 A/20.5 V...250 A/30.0 V
	TIG	5 A/10.0 V...300 A/22.0 V
Max welding voltage		36 V / 250 A
Stick electrodes		Ø 1.5 ... 5.0 mm
Open circuit voltage		80 V
Welding current control		stepless
Efficiency at max. current		86 % (250 A/30.0 V)
Power factor at max. current		0.95 (250 A/30.0 V)
Idle power		approx. 10 W
Degree of protection		IP23S
EMC class		A
Minimum short circuit power S_{sc} of supply network*		1.6 MVA
External dimensions (TIG power source + cooling unit)	LxWxH	500 x 180 x 390 (650) mm
Weight		22 kg

Power source Mastertig MLS™ 4000		
Connection voltage	3~ 50/60 Hz	400V –15%...+20%
Rated power at max. current	30% ED TIG	13.8 kVA
	40% ED MMA	15 kVA
Connection cable	H07RN-F	4G2.5(5m)
Fuse (delayed)		16 A
Duty cycle 40 °C	TIG	5 A/10.0 V ... 400 A/26.0 V
	MMA	10 A/20.5 V ... 350 A/34.0 V
Max welding voltage		45.0 V / 350 A
Stick electrodes		Ø 1.5 ... 6.0 mm
Open circuit voltage		80 V
Welding current control		stepless
Efficiency at max. current		86 % (350 A/34.0 V)
Power factor at max. current		0.95 (350 A/34.0 V)
Idle power		approx. 10 W
Degree of protection		IP23S
EMC class		A
Minimum short circuit power S_{sc} of supply network*		2.5 MVA
External dimensions (TIG power source + cooling unit)	LxWxH	500 x 180 x 390 (650) mm
Weight		23 kg

Cooling unit (TIG-welding) MasterCool 10		
Operating voltage		400V –15%...+20%
Connection capacity	100 % ED	250 W
Cooling power		1 kW
Start pressure, max		0.4 MPa
Cooling liquid		20% – 40 % etanol-water
Tank volume		3 l
External dimensions	LxWxH	500x180x260 mm
Weight		11 kg
Power source and cooling unit		
Operating temperature range		-20 °C ... +40 °C
Storage temperature range		-40 °C ... +60 °C
EMC class		A
Degree of protection		IP23S

KEMPPI OY

Hennalankatu 39
PL 13
FIN-15801 LAHTI
FINLAND
Tel +358 3 899 11
Telefax +358 3 899 428
export@kempfi.com
www.kempfi.com

Kotimaan myynti:

Tel +358 3 899 11
Telefax +358 3 734 8398
myynti.fi@kempfi.com

KEMPPI SVERIGE AB

Box 717
S-194 27 UPPLANDS VÄSBY
SVERIGE
Tel +46 8 590 783 00
Telefax +46 8 590 823 94
sales.se@kempfi.com

KEMPPI NORGE A/S

Postboks 2151, Postterminalen
N-3103 TØNSBERG
NORGE
Tel +47 33 346000
Telefax +47 33 346010
sales.no@kempfi.com

KEMPPI DANMARK A/S

Literbuen 11
DK-2740 SKOVLUNDE
DANMARK
Tel +45 4494 1677
Telefax +45 4494 1536
sales.dk@kempfi.com

KEMPPI BENELUX B.V.

Postbus 5603
NL-4801 EA BREDA
NEDERLAND
Tel +31 765717750
Telefax +31 765716345
sales.nl@kempfi.com

KEMPPI (UK) Ltd

Martti Kempfi Building
Fraser Road
Priory Business Park
BEDFORD, MK44 3WH
UNITED KINGDOM
Tel +44 (0)845 6444201
Telefax +44 (0)845 6444202
sales.uk@kempfi.com

KEMPPI FRANCE S.A.S.

65 Avenue de la Couronne des Prés
78681 EPONE CEDEX
FRANCE
Tel +33 1 30 90 04 40
Telefax +33 1 30 90 04 45
sales.fr@kempfi.com

KEMPPI GmbH

Otto-Hahn-Straße 14
D-35510 BUTZBACH
DEUTSCHLAND
Tel +49 6033 88 020
Telefax +49 6033 72 528
sales.de@kempfi.com

KEMPPI SPÓŁKA Z O.O.

Ul. Borzymowska 32
03-565 WARSZAWA
POLAND
Tel +48 22 7816162
Telefax +48 22 7816505
info.pl@kempfi.com

KEMPPI AUSTRALIA PTY LTD.

13 Cullen Place
P.O. Box 5256, Greystanes NSW 2145
SMITHFIELD NSW 2164
AUSTRALIA
Tel. +61 2 9605 9500
Telefax +61 2 9605 5999
info.au@kempfi.com

ООО КЕМПИ

Polkovaya str. 1, Building 6
127018 MOSCOW
RUSSIA
Tel +7 495 739 4304
Telefax +7 495 739 4305
info.ru@kempfi.com

ООО КЕМПИ

ул. Полковая 1, строение 6
127018 Москва
Tel +7 495 739 4304
Telefax +7 495 739 4305
info.ru@kempfi.com

KEMPPI, TRADING (BEIJING) COMPANY, LIMITED

Room 420, 3 Zone, Building B,
No.12 Hongda North Street,
Beijing Economic Development Zone,
100176 Beijing
CHINA
Tel +86-10-6787 6064
+86-10-6787 1282
Telefax +86-10-6787 5259
sales.cn@kempfi.com
肯倍贸易 (北京) 有限公司
中国北京经济技术开发区宏达北路12号
创新大厦B座三区420室 (100176)
电话 : +86-10-6787 6064
+86-10-6787 1282
传真 : +86-10-6787 5259
sales.cn@kempfi.com

KEMPPI INDIA PVT LTD

LAKSHMI TOWERS
New No. 2/770,
First Main Road,
KAZURA Gardens,
Neelangarai,
CHENNAI - 600 041
TAMIL NADU
Tel +91-44-4567 1200
Telefax +91-44-4567 1234
sales.india@kempfi.com